



Medical Serie +600M



- Modular
- Configurable
- Patents pending
- Reduced fan noise
- Enhanced Line Derating

600 watts in the palm of your hand

The +600M Series features improved low input line derating delivers 600 watts without the need to derate for line voltages above 120Vac making the +600M the ultimate power solution for products destined for the global market. Through the implementation of a fan control circuit the +600M also features reduced fan noise. The +600M delivers up to 600 watts from a 600 gram 5" x 3" x 1U package and consists of an input module together with up to four isolated output modules. The series carry full UL60601 safety approvals and comply with EN61000-3, EN61000-4 and EN550022-B EMC standards.



MAIN FEATURES:

- ✓ No Line derating above 120VAC
- ✓ Reduced fan noise
- ✓ 600 watt output
- ✓ 5" x 3" x 1U footprint
- ✓ High power density (25W/in³)
- ✓ Medical approvals
- ✓ High reliability
- ✓ High efficiency – up to 89%
- ✓ Only 0.6kg – 100W/kg
- ✓ I²C control option
- ✓ Remote current/voltage programming
- ✓ Current output signal
- ✓ Accurate current sharing
- ✓ 5V 200mA bias supply
- ✓ RoHS compliant
- ✓ Field configurable
- ✓ Two year warranty

SYSTEM SPECIFICATIONS

INPUT ELECTRICAL						
Parameter	Details	Min	Typ	Max	Units	
AC Input Voltage	Nominal range is 100Vrms to 240Vrms	85		264	Vrms	
AC Input Frequency	Contact factory for 400Hz operation.	47	50/60	63	Hz	
DC Input Voltage	Medical	120		300	Vdc	
Power Rating	See graphs for deratings			600	Watts	
Input Current	600Watts output at 120Vrms input			6	Amps	
Inrush Current	265Vrms (cold start)			20	Amps	
Fusing	5x20 Fast acting			8	Amps	
Input Current Limit	Maintains power factor		8		Amps	
Efficiency	See graphs		86	89	%	
Idle Power	All outputs fitted and enabled		28		Watts	
Idle Power	All outputs fitted and Disabled		21		Watts	
Power Factor	Typical value for 300Watts output at 240Vrms input		0.96	0.99		
Holdup	600Watts output at 120Vrms input	17	20	21	mS	
UVLO	Turn on only	78		84	Vrms	
Over temperature	Internally monitored. Latching	115		125	°C	
Reliability	40°C 80% load			2	FPMH	
S i g n a l s	Bias Voltage	4.8	5	5.2	V	
	Bias current	0		200	mA	
	Power Good voltage	PNP open collector with internal 10k pull down resistor	8	10	15	V
	Power Good current		0		20	mA
	Inhibit voltage		2		15	V
	Inhibit current	10k ohm input impedance	0.2		1.5	mA
	Global inhibit voltage		3		15	V
	Global inhibit current	5k ohm input impedance	0.6		3	mA
	AC_OK voltage		1		4	V
	AC_OK current		-10		20	mA
AC_OK warning	See user manual for exceptions	5			mS	

INSTALLATION			
Parameter	Details	Parameter	Details
Equipment class	I	Flammability rating	94V-2
Installation category	II	IP Rating	IP10
Pollution degree	2	ROHS Compliance	2002/95/EC
Material group	IIIb (indoor use only)		

RELIABILITY				
Component	Details	Min	Max	Units
FAN	Mag Lev Std		2.7	FPMH
INPUT	Excluding FAN		2	FPMH
OUTPUT	See individual output datasheets		1	FPMH
Warranty			2	Years

SAFETY				
Parameter	Details	Min	Max	Units
Isolation Voltage	Input to Output		4000	Vac
	Input to Chassis		1500	Vac
	Output to Chassis		250	Vdc
	Output to Output		250	Vdc
Isolation Clearance	Primary to Secondary (Reinforced)	7		mm
	Primary to Chassis (Basic)	2.5		mm
Isolation Creepage	Primary to Secondary (Reinforced)	12		mm
	Primary to Chassis (Basic)	4		mm
Leakage Current	Medical: 265Vac, 63Hz, 25°C		300	uA

MECHANICAL	
Parameter	Details
Size	77.7mm x 133.7mm x 41.0mm (all external dimensions ± 1.0mm)
Weight	360 gram +60 gram per output module
Mounting	Bottom or Side mounting (See diagram for details)

Medical Serie +600M



Patents pending

ENVIRONMENTAL					
	Parameter	Details	Min	Max	Units
Storage	Temperature		-40	+85	°C
	Humidity	Relative, non-condensing	5	95	%
	Altitude		-200	5000	m
	Air Pressure		54	106	kPa
Operation	Temperature	Full power	-20	50	°C
		Derate input and outputs at 2.5%/°C	50	70	°C
	Humidity	Relative, non-condensing	5	95	%
	Altitude	(-200 to 2000m for UL60601-1)	-200	3000	m
	Air Pressure		78	106	kPa
	Noise Level	Variable. Measured 1m from fan intake	35	60	dBA
	Shock	3000 bumps at 10G (16ms) half sine wave			
	Vibration	1.5G 10 to 200Hz sine wave, 20G for 15min in 3 axes random vibration			

EMC			
	Parameter	Standard	Level
Emissions	Radiated electric field	EN55011, EN55022, FCC	B
	Conducted emissions	EN55011, EN55022, FCC	B
	Harmonic Distortion	EN61000-3-2	Compliant
	Flicker & Fluctuation	EN61000-3-3	Compliant
Immunity	Electrostatic discharge	EN61000-4-2 (15kV air, 8kV contact)	4
	Radiated RFI	EN61000-4-3 (10V/m)	3
	Fast Transient burst	EN61000-4-4 (4kV)	4
	Input line surges	EN61000-4-5 (1kV L-N, 2kV L-E)	3
	Conducted RFI	EN61000-4-6 (10V)	4
	Power Freq. Magnetic Field	EN61000-4-8 (10A/m)	3
	Voltage Dips	EN61000-4-11 (EN55024)	Compliant

Typical Conducted Emmissions

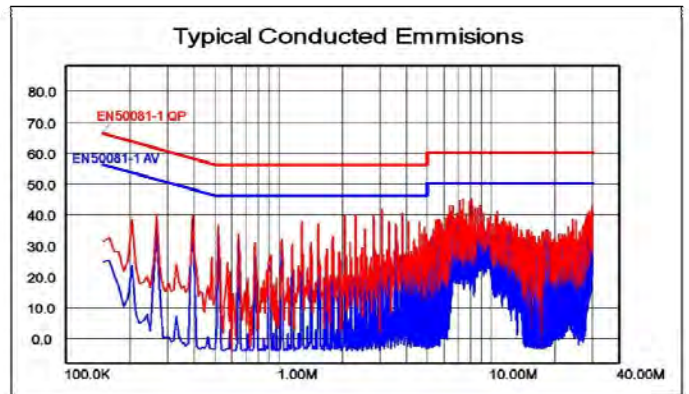

AGENCY APPROVALS

Standard	Details	Standard	Details
IEC/EN60601-1			
UL60601-1			
CSA-C22.2 No. 60601-1-08			
CE MARK	LVD 73/23/EEC	UL file number	UL: E316486

CB certificate and report available on request

Typical Load Efficiency

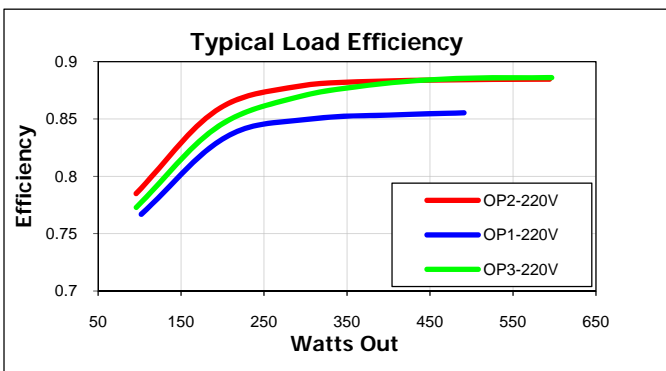

Typical Line Efficiency

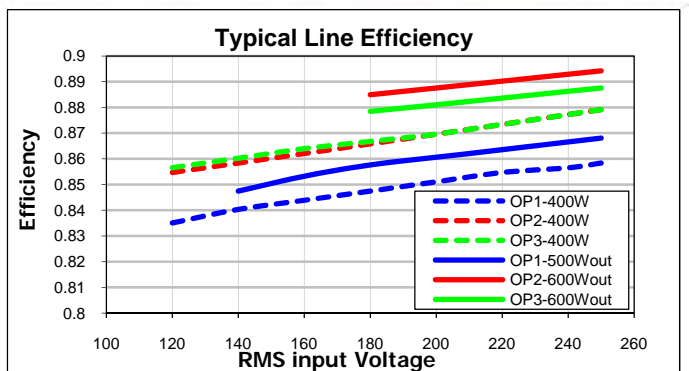

Line Derating

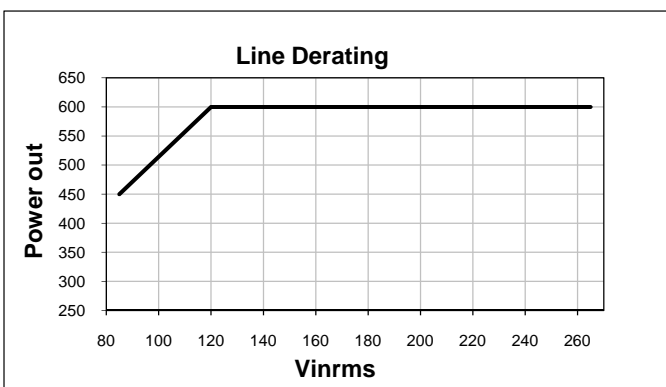

Temperature Derating

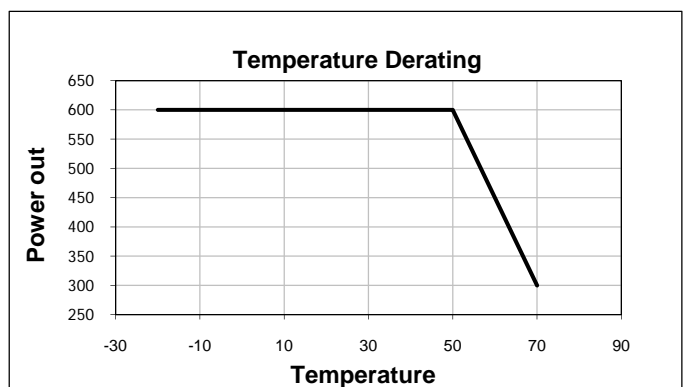

Medical Serie +600M

MECHANICAL DIMENSIONS AND MOUNTING SCREWS

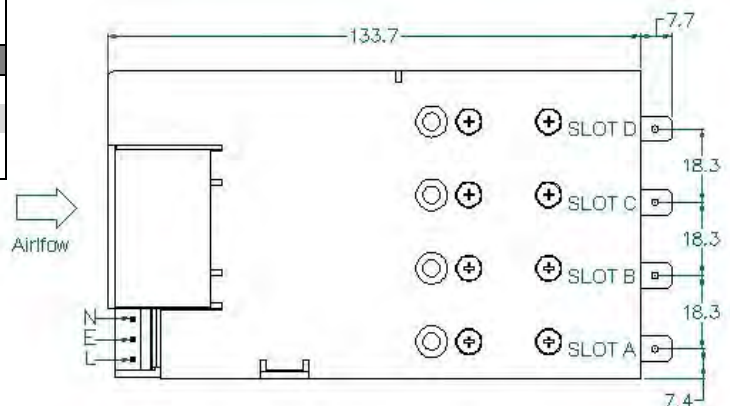
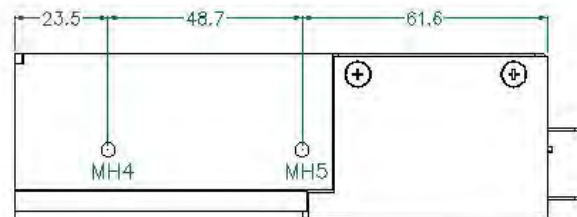
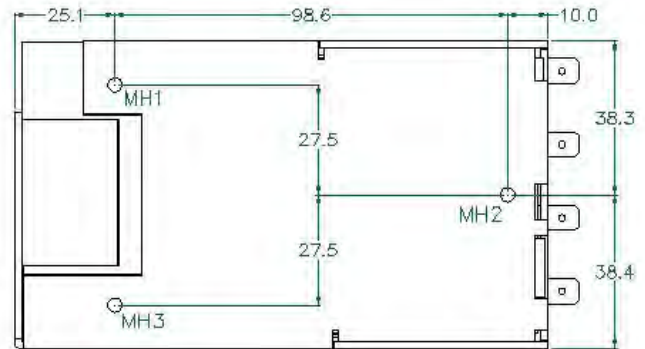
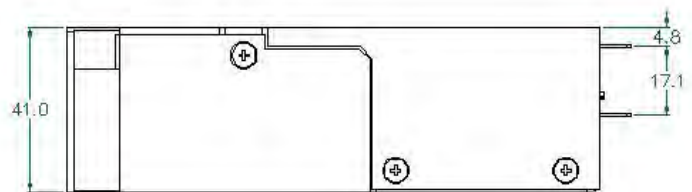
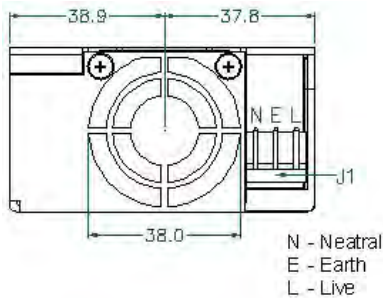

SCREWS	
MH1, MH2, MH3, MH4, MH5	
Screw type	M4
Tightening	Tighten to 1.5 Nm
Penetration depth	4.00mm max including chassis
OUTPUT MODULES x 8	
Screw type	M3x5, C/Sink, Posi, Stainless Steel
Tightening	Tighten to 0.75 Nm
Penetration depth	Defined by screw
CHASSIS x 5	
Screw type	M3x5, C/Sink, Posi, Stainless Steel
Tightening	Tighten to 0.75 Nm
Penetration depth	Defined by screw
FAN x 2	
Screw type	M3x24, C/Sink, Posi, Stainless Steel
Tightening	Tighten to 0.75 Nm
Penetration depth	Defined by screw

Medical Serie +600M

Patents pending

CONNECTORS

PINOUTS		
J1		
Circuit	Details	
1	Live	
2	Earth	
3	Neutral	
J2		
Circuit	Details	
1	Power Good	Slot A
2	Inhibit	
3	Power Good	Slot B
4	Inhibit	
5	Power Good	Slot C
6	Inhibit	
7	Power Good	Slot D
8	Inhibit	
9	Global Inhibit	
10	AC OK	
11	+5V 200mA Bias Supply	
12	COM	
J5		
Circuit	Details	
1	-Sense	
2	+Sense	
3	Voltage Control	
4	Current Control / Share / Out	
5	COM	
6	+5V local bias supply	

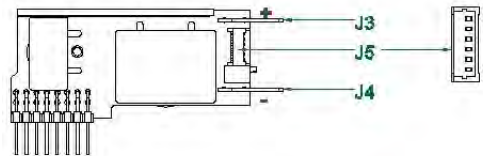
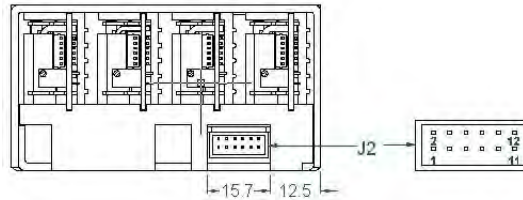
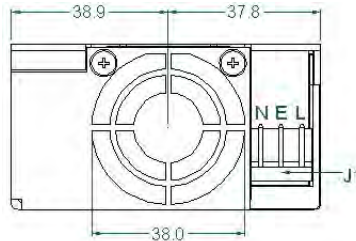

J3
Positive Output
J4
Negative Output

REF.	DETAILS	MANUFACTURER	TERMINAL
J1	MAINS INPUT: 3 Pin, 5.08mm, with Friction Lock, 18-24 AWG	MOLEX	8701031
J2	GLOBAL SIGNALS: 12 Pin, 2mm, with Friction Lock, 24-30 AWG	MOLEX	503948051
J2	IDT ALTERNATIVE FOR J2	MOLEX	N/A
J3/4(1)	OUTPUT POWER TERMINAL: TAB SIZE 6.35mmx0.8mm	VARIOUS	N/A
J5	OUTPUT SIGNALS: 6 Pin, 1.25mm, with Friction lock, 28-32 AWG	MOLEX	1510210600 / 50058800

Notes

- Terminal and Wire current rating must exceed maximum short circuit output current. Eg. Output 1 = 25A*1.25 = 31.25Amps
- Direct equivalents may be used for any connector parts
- All cables must be rated 105°C min, equivalent to UL1015

PART NUMBERING SYSTEM

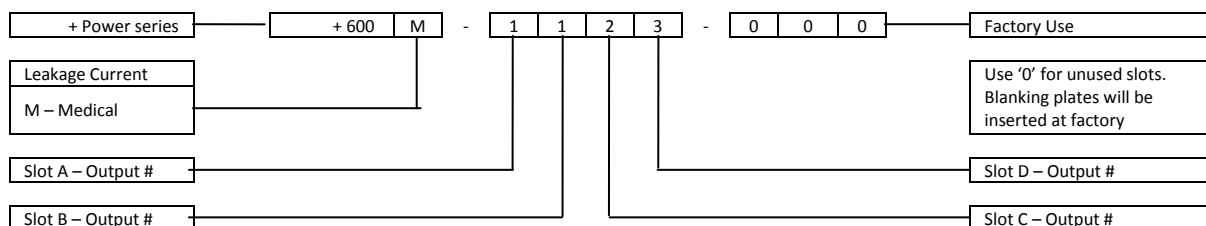

When initially ordering non-nominal voltage settings add "/Voltage" after each output # where a special voltage setting is required
E.g. If 3.30Vdc is required in slot B and all other slots require nominal voltages then use:

+ 600M - 1 - 1/3.30 - 2 - 3

The factory will then issue a 3 digit code for your specific configuration that can be used for all future orders of the same configuration
When ordering an input unit with no outputs inserted, simply order + 600M



Patents pending

OP1 module 125W

Output voltage range 1,5V-7,5V 25A

OUTPUT 1 SPECIFICATIONS					
Parameter	Details	Min	Typ	Max	Units
Output voltage range	See table	1.5	5	7.5	V
Rated current				25	A
Average output power				125	Watts
Peak output power	See graph, < 5 seconds 50% duty cycle			187.5	Watts
Initial voltage accuracy	Factory set units	-0.5		0.5	%
Manual Voltage Adjust	11 turn potentiometer		0.545		V/turn
Load Regulation	Measured at sense terminals	-50		50	mV
Line Regulation	Measured at sense terminals	-0.1		0.1	%Vnom
Cross Regulation	Measured at sense terminals	-0.2		0.2	%Vnom
Minimum Load				0	Watts
Temperature coefficient		-0.02		0.02	%/°C
Ripple and Noise	20MHz BW, pk-pk			1	%Vnom
Transient response	25% to 75% load transient at 1A/us			1	V
	Recovery to within 10% of Vset			100	uS
Turn on rise time	Monotonic 10% to 90%	1.5		3.5	mS
Turn on overshoot				0.1	%Vset
Turn on delay	AC to PG		600	750	mS
	En to PG		15	20	mS
Current share accuracy				5	%Imax
Open sense offset	Open sense, voltage offset due to bias currents			2	%Vnom
Holdup voltage				6	V
Isolation to ground	Each terminal			250	V
Over current protection	% of rated current	105		125	%rated
Reverse current protection	% of rated current	-6		0	%rated
Short circuit protection (Hiccup mode)	Period		125		mS
	Duty cycle		3		%
	Voltage threshold (Measured at sense terminals)		1		V
Over voltage protection	Latching		9.5		V
Over Temperature protection	Internally monitored. Latching	115		125	°C
Sense cable protection	Positive	-1		2	V
	Negative			1	V
Power Good threshold	Low threshold only		90		%Vset
Current output signal	$I_{SIG} = 0.6 + I_{OUT} / (I_{RTD} * 1.25)$	0		110	%Irated
Current limit control	$I_{LMT} = (V_{CTRL} - 0.6) * I_{RTD} * 1.25$	0		110	%Irated
Remote voltage control	$V_{OUT} = V_{SET} * ((1.8 - V_{CTRL}) / 0.6)$	0		300	%Vset
Bias supply	10mA max	4.5	5	5.2	V
Reliability	40°C 80% load			1	FPMH
Warranty				2	Years
Wire Size		12	10		AWG
Weight				60	Grams
Size	60mm x 35mm x 17mm				

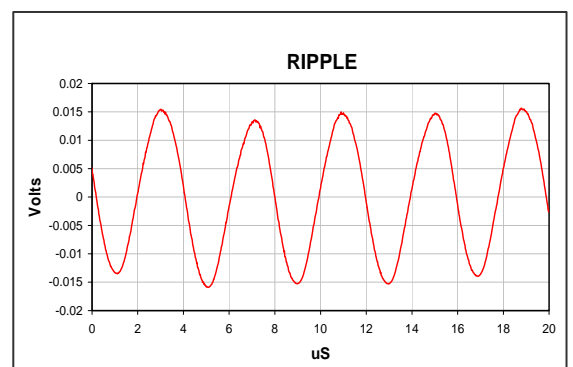
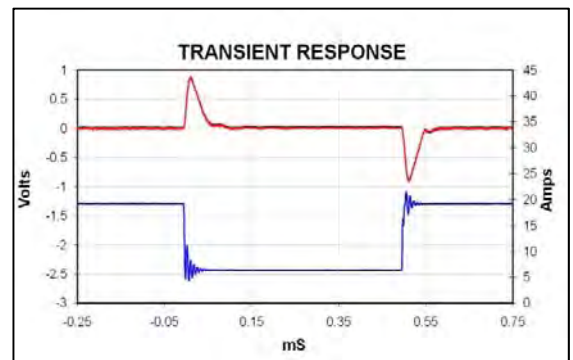
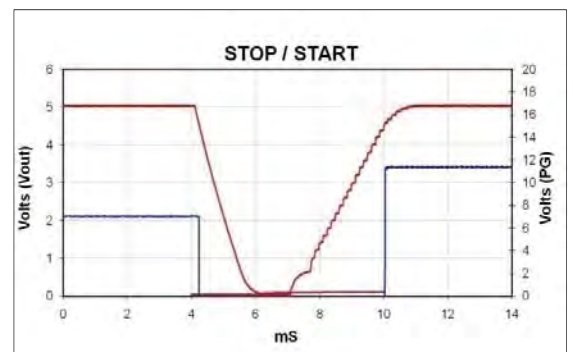
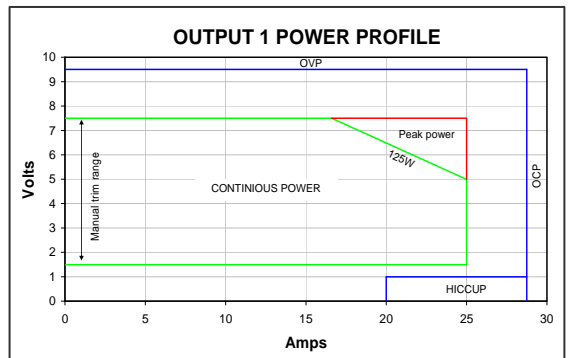

Notes: All specifications are believed to be correct at time of publication and are subject to change without notice.



Patents pending

OP2 module 150W

Output voltage range 4,5V-15V 15A

OUTPUT 2 SPECIFICATIONS					
Parameter	Details	Min	Typ	Max	Units
Output voltage range	See table	4.5	12	15	V
Rated current				15	A
Average output power				150	Watts
Peak output power	See graph, < 5 seconds 50% duty cycle			225	Watts
Initial voltage accuracy	Factory set units	-0.5		0.5	%
Manual Voltage Adjust	11 turn potentiometer		0.954		V/turn
Load Regulation	Measured at sense terminals	-100		100	mV
Line Regulation	Measured at sense terminals	-0.1		0.1	%Vnom
Cross Regulation	Measured at sense terminals	-0.2		0.2	%Vnom
Minimum Load				0	Watts
Temperature coefficient		-0.02		0.02	%/°C
Ripple and Noise	20MHz BW, pk-pk			1	%Vnom
Transient response	25% to 75% load transient at 0.5A/uS			1.5	V
	Recovery to within 10% of Vset			100	uS
Turn on rise time	Monotonic 10% to 90%	1.5		3.5	mS
Turn on overshoot				0.1	%Vset
Turn on delay	AC to PG		600	750	mS
	En to PG		15	20	mS
Current share accuracy				5	%Imax
Open sense offset	Open sense, voltage offset due to bias currents			2	%Vnom
Holdup voltage				12.5	V
Isolation to ground	Each terminal			250	V
Over current protection	% of rated current	105		125	%rated
Reverse current protection	% of rated current	-6		0	%rated
Short circuit protection (Hiccup mode)	Period		125		mS
	Duty cycle		3		%
	Voltage threshold (Measured at sense terminals)		2		V
Over voltage protection	Latching		18		V
Over Temperature protection	Internally monitored. Latching	115		125	°C
Sense cable protection	Positive	-1		2	V
	Negative			1	V
Power Good threshold	Low threshold only		90		%Vset
Current output signal	$I_{SIG} = 0.6 + I_{OUT} / (I_{RTD} * 1.25)$	0		110	%Irated
Current limit control	$I_{LMT} = (V_{CTRL} - 0.6) * I_{RTD} * 1.25$	0		110	%Irated
Remote voltage control	$V_{OUT} = V_{SET} * ((1.8 - V_{CTRL}) / 0.6)$	0		300	%Vset
Bias supply	10mA max	4.5	5	5.2	V
Reliability	40°C 80% load			1	FPMH
Warranty				2	Years
Wire Size		16	14	10	AWG
Weight				60	Grams
Size	60mm x 35mm x 17mm				

Notes: All specifications are believed to be correct at time of publication and are subject to change without notice.

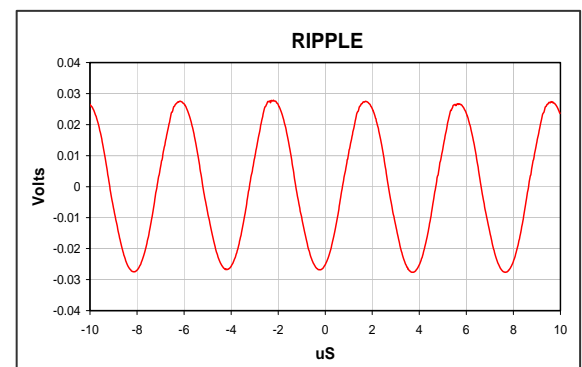
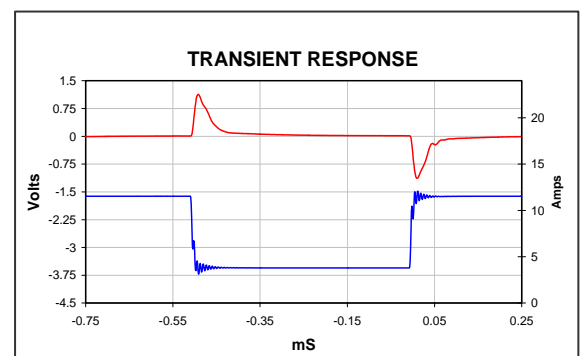
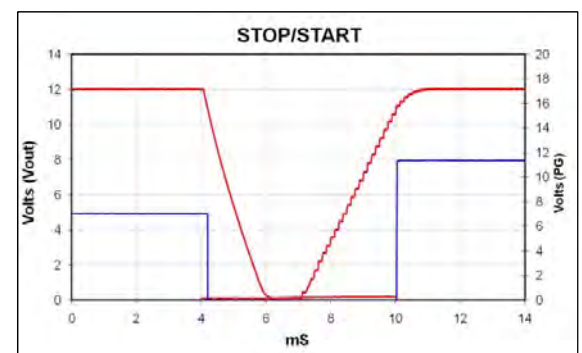
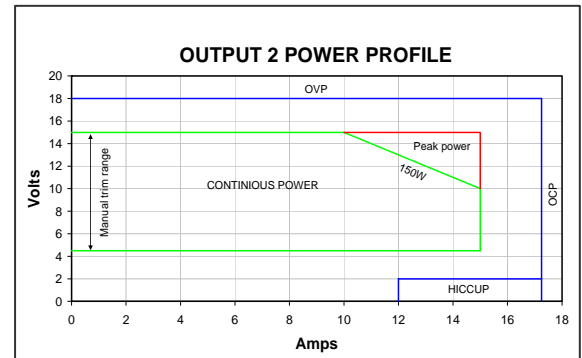



Patents pending

OP3 module 150W

output range 9V- 30V 7,5A

OUTPUT 3 SPECIFICATIONS					
Parameter	Details	Min	Typ	Max	Units
Output voltage range	See table	9	24	30	V
Rated current				7.5	A
Average output power				150	Watts
Peak output power	See graph, < 5 seconds 50% duty cycle			225	Watts
Initial voltage accuracy	Factory set units	-0.5		0.5	%
Manual Voltage Adjust	11 turn potentiometer		1.9		V/turn
Load Regulation	Measured at sense terminals	-150		150	mV
Line Regulation	Measured at sense terminals	-0.1		0.1	%Vnom
Cross Regulation	Measured at sense terminals	-0.2		0.2	%Vnom
Minimum Load				0	Watts
Temperature coefficient		-0.02		0.02	%/°C
Ripple and Noise	20MHz BW, pk-pk			1	%Vnom
Transient response	25% to 75% load transient at 0.25A/uS Recovery to within 10% of Vset			3	V
Turn on rise time	Monotonic 10% to 90%	1.5		3.5	mS
Turn on overshoot				0.1	%Vset
Turn on delay	AC to PG En to PG		600 15	750 20	mS
Current share accuracy				5	%Imax
Open sense offset	Open sense, voltage offset due to bias currents			2	%Vnom
Holdup voltage				25	V
Isolation to ground	Each terminal			250	V
Over current protection	% of rated current	105		125	%rated
Reverse current protection	% of rated current	-6		0	%rated
Short circuit protection (Hiccup mode)	Period Duty cycle Voltage threshold (Measured at sense terminals)		125 3 3.5		mS % V
Over voltage protection	Latching		36		V
Over Temperature protection	Internally monitored. Latching	115		125	°C
Sense cable protection	Positive Negative	-1		2 1	V V
Power Good threshold	Low threshold only		90		%Vset
Current output signal	$I_{SIG} = 0.6 + I_{OUT} / (I_{RTD} * 1.25)$	0		110	%Irated
Current limit control	$I_{LMT} = (V_{CTRL} - 0.6) * I_{RTD} * 1.25$	0		110	%Irated
Remote voltage control	$V_{OUT} = V_{SET} * ((1.8 - V_{CTRL}) / 0.6)$	0		300	%Vset
Bias supply	10mA max	4.5	5	5.2	V
Reliability	40°C 80% load			1	FPMH
Warranty				2	Years
Wire Size		20	18	10	AWG
Weight				60	Grams
Size	60mm x 35mm x 17mm				

Notes: All specifications are believed to be correct at time of publication and are subject to change without notice.

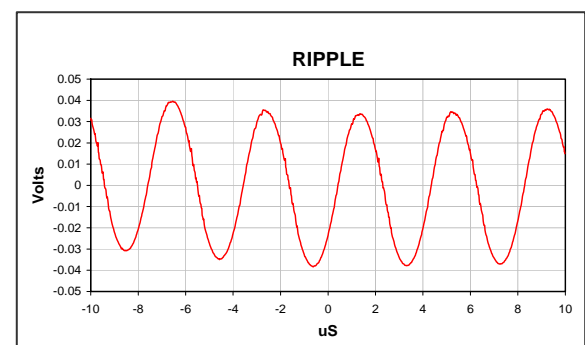
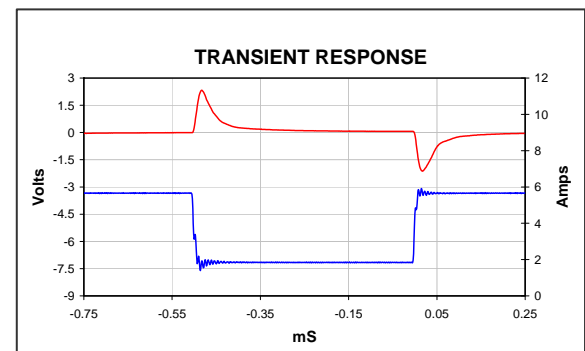
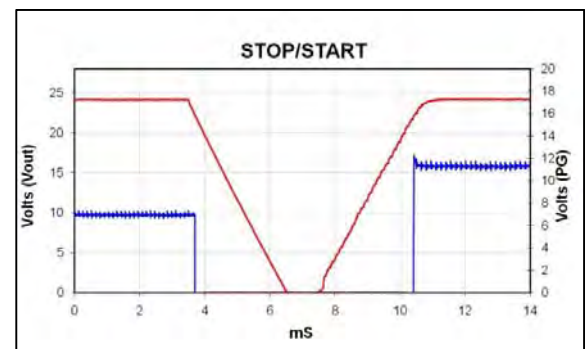
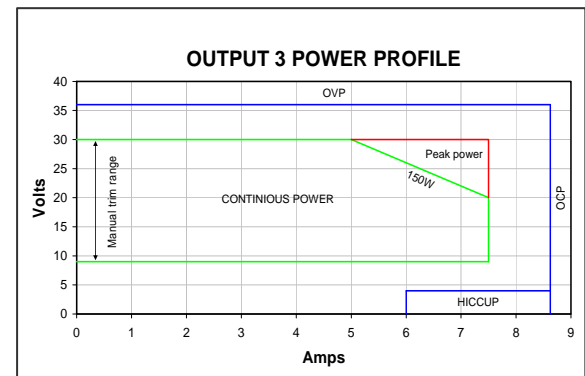



Patents pending

OP4 module 150W

Output voltage range 18V-58V 3,75A

OUTPUT 4 SPECIFICATIONS					
Parameter	Details	Min	Typ	Max	Units
Output voltage range	See table	18	48	58	V
Rated current				3.75	A
Average output power				150	Watts
Peak output power	See graph, < 5 seconds 50% duty cycle			225	Watts
Initial voltage accuracy	Factory set units	-0.5		0.5	%
Manual Voltage Adjust	11 turn potentiometer		3.6		V/turn
Load Regulation	Measured at sense terminals	-300		300	mV
Line Regulation	Measured at sense terminals	-0.1		0.1	%Vnom
Cross Regulation	Measured at sense terminals	-0.2		0.2	%Vnom
Minimum Load				0	Watts
Temperature coefficient		-0.02		0.02	%/°C
Ripple and Noise	20MHz BW, pk-pk			1	%Vnom
Transient response	25% to 75% load transient at 0.25A/uS			3	V
	Recovery to within 10% of Vset			100	uS
Turn on rise time	Monotonic 10% to 90%	1.5		3.5	mS
Turn on overshoot				0.1	%Vset
Turn on delay	AC to PG		600	750	mS
	En to PG		15	20	mS
Current share accuracy				5	%Imax
Open sense offset	Open sense, voltage offset due to bias currents			2	%Vnom
Holdup voltage				50	V
Isolation to ground	Each terminal			250	V
Over current protection	% of rated current	105		125	%rated
Reverse current protection	% of rated current	-6		0	%rated
Short circuit protection (Hiccup mode)	Period		125		mS
	Duty cycle		3		%
	Voltage threshold (Measured at sense terminals)		3.5		V
Over voltage protection	Latching		66		V
Over Temperature protection	Internally monitored. Latching	115		125	°C
Sense cable protection	Positive	-3		3	V
	Negative			2	V
Power Good threshold	Low threshold only		90		%Vset
Current output signal	$I_{SIG} = 0.6 + I_{OUT} / (I_{RTD} * 1.25)$	0		110	%Irated
Current limit control	$I_{LMT} = (V_{CTRL} - 0.6) * I_{RTD} * 1.25$	0		110	%Irated
Remote voltage control	$V_{OUT} = V_{SET} * (1.8 - V_{CTRL}) / 0.6$	0		300	%Vset
Bias supply	10mA max	4.5	5	5.2	V
Reliability	40°C 80% load			1	FPMH
Warranty				2	Years
Wire Size		20	18	10	AWG
Weight				60	Grams
Size	60mm x 35mm x 17mm				

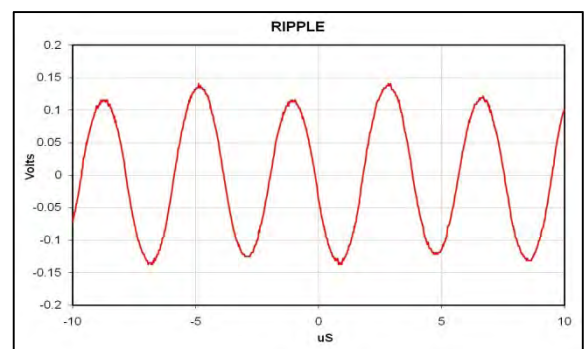
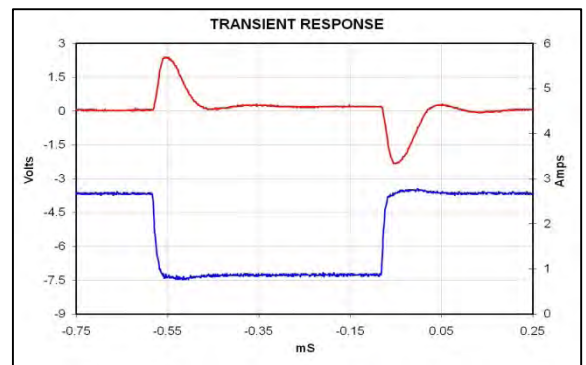
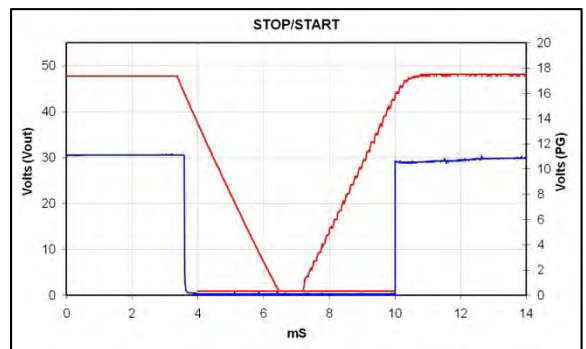
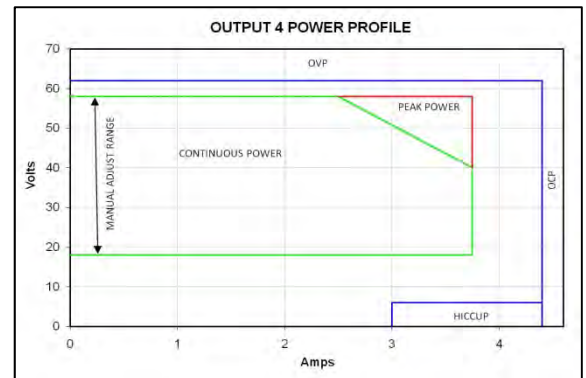

Notes: All specifications are believed to be correct at time of publication and are subject to change without notice.



Patents pending

OP5 module 150W

Dual output voltage range 5V-15V 5A

OUTPUT 5 SPECIFICATIONS					
Parameter	Details	Min	Typ	Max	Units
Output voltage range	Each channel	5	12	15	V
Rated current	Each channel			5	A
Average output power	Each channel			75	Watts
Initial voltage accuracy	Factory set units	-1		1	%
Manual Voltage Adjust	11 turn potentiometer		0.9		V/turn
Load Regulation	Measured at terminals	-50		50	mV
Line Regulation	Measured at terminals	-0.1		0.1	%Vnom
Cross Regulation	Measured at terminals	-0.2		0.2	%Vnom
Minimum Load				0	Watts
Temperature coefficient		-0.02		0.02	%/°C
Ripple and Noise	20MHz BW, pk-pk			150	mV
Transient response	25% to 75% load transient at 0.5A/uS Recovery to within 10% of Vset			1	V
Turn on rise time	Monotonic 10% to 90%	1.5		3.5	mS
Turn on overshoot				0.1	%Vset
Turn on delay	AC to PG En to PG		600	750	mS
Holdup voltage			15	20	mS
Isolation to ground	Each terminal			250	V
Over current protection	% of rated current	110		150	%rated
Reverse current protection	None				
Short circuit protection (Hiccup mode)	Period Duty cycle		125 3		mS %
Over voltage protection	Latching		20		V
Over Temperature protection	Internally monitored. Latching	115		125	°C
Power Good threshold	Low threshold only		90		%Vset
Reliability	40°C 80% load			1	FPMH
Warranty				2	Years
Wire Size		20	18	10	AWG
Weight				60	Grams
Size	60mm x 35mm x 17mm				

Notes: All specifications are believed to be correct at time of publication and are subject to change without notice.

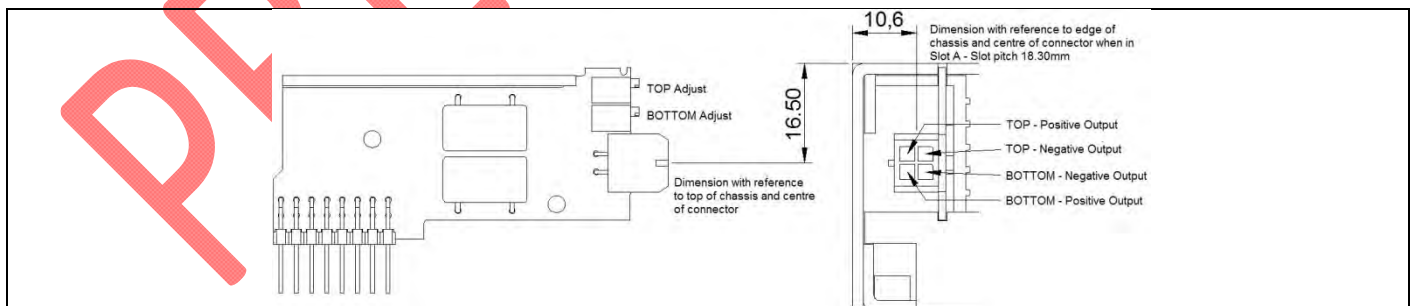
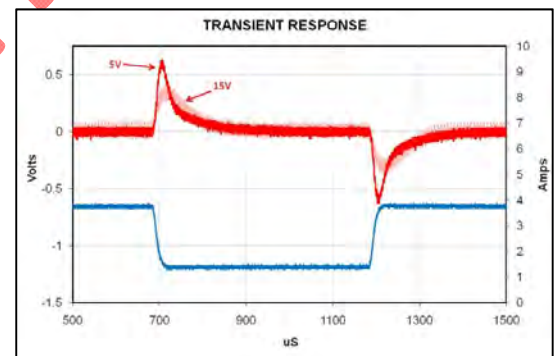
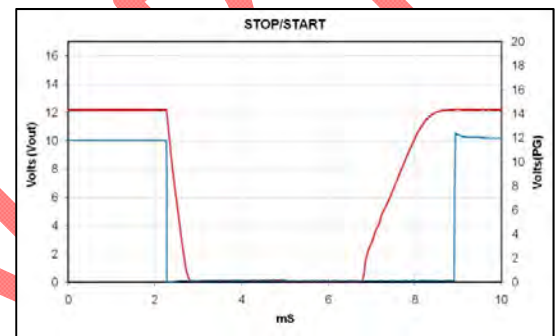
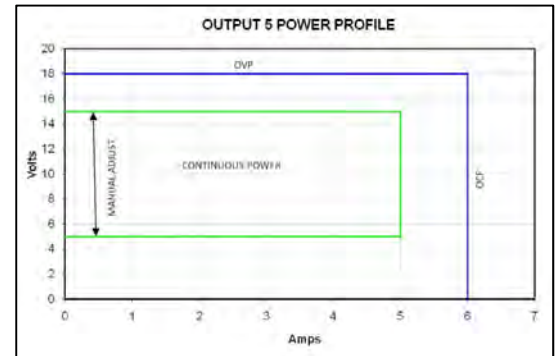

REF.	DETAILS	MANUFACTURER	HOUSING	TERMINAL
J1	OUTPUT POWER CONNECTOR: 4 Pin, with Friction lock, 20-24 AWG	MOLEX	430250400	430300001

Notes: 1. Terminal and Wire current rating must exceed maximum output current. 2. Direct equivalents may be used for any connector parts 3. All cables must be rated 105°C min, equivalent to UL1015



Patents pending

OP6 module 50W

Dual output voltage range 1,8V-5V 5A

OUTPUT 6 SPECIFICATIONS					
Parameter	Details	Min	Typ	Max	Units
Output voltage range	Each channel	1.8	3.3	5	V
Rated current	Each channel			5	A
Average output power	Each channel		16.5	25	Watts
Initial voltage accuracy	Factory set units	-1		1	%
Manual Voltage Adjust	11 turn potentiometer		0.3		V/turn
Load Regulation	Measured at sense terminals	-50		50	mV
Line Regulation	Measured at sense terminals	-0.1		0.1	%Vset
Cross Regulation	Measured at sense terminals	-0.2		0.2	%Vset
Minimum Load				0	Watts
Temperature drift	-20°C to +50°C	-0.02		0.02	%/°C
Ripple and Noise	20MHz BW, pk-pk			2	%Vset
Transient response (Vset = 3.3V)	25% to 75% load transient at 1A/uS			0.5	V
	Recovery to within 10% of Vset			100	uS
Turn on rise time	Monotonic 10% to 90%	1		3.5	mS
Turn on overshoot				0.1	%Vset
Turn on delay	AC to PG		600	750	mS
	En to PG		15	20	mS
Holdup voltage				5	V
Isolation to ground	Each terminal			250	V
Over current protection	% of rated current	105		130	%rated
Reverse current protection	None				
Short circuit protection (Hiccup mode)	Period Duty cycle		30 1		mS %
Over voltage protection	Latching		8		V
Over Temperature protection	Internally monitored. Latching	115		125	°C
Power Good threshold	High and low window	68		120	%Vset
Reliability	25°C 100% load Telcordia			1	FPMH
Warranty				2	Years
Wire Size		24	22	20	AWG
Weight				60	Grams
Size	60mm x 35mm x 17mm				

Notes: All specifications are believed to be correct at time of publication and are subject to change without notice.

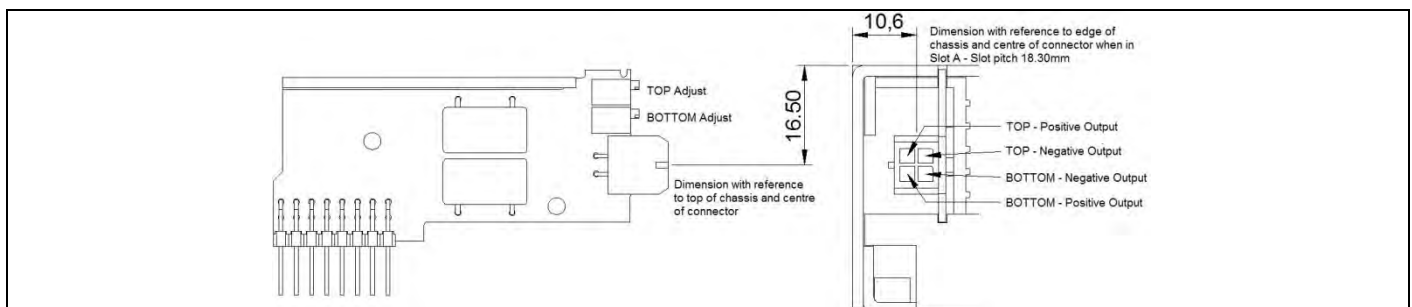
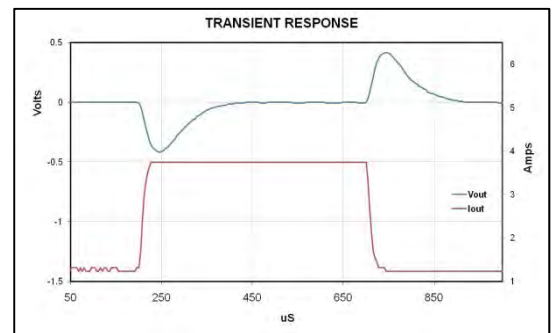
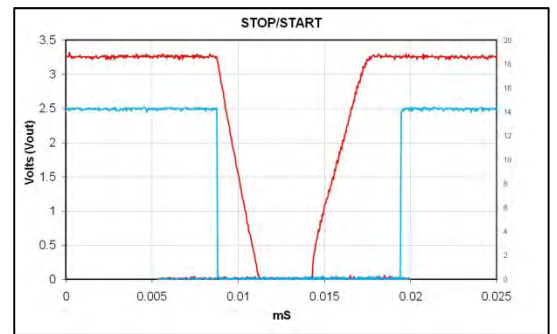
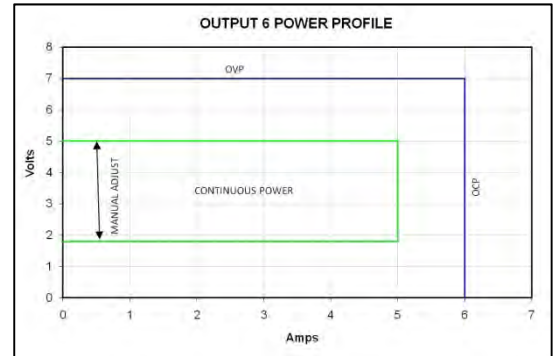

REF.	DETAILS	MANUFACTURER	HOUSING	TERMINAL
J1	OUTPUT POWER CONNECTOR: 4 Pin, with Friction lock, 20-24 AWG	MOLEX	430250400	430300001

Notes: 1. Terminal and Wire current rating must exceed maximum output current. 2. Direct equivalents may be used for any connector parts 3. All cables must be rated 105°C min, equivalent to UL1015

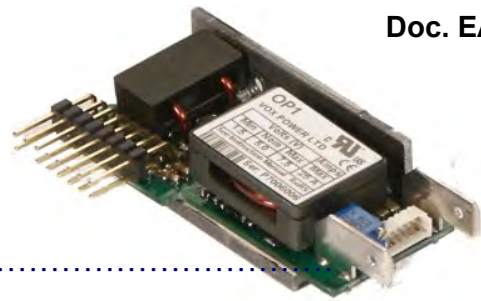

Patents pending

CD+ 'a cXi `Y%') K 8i U `ci hdi hj c`hU[Y`fUb[Y`%ž, #) J) 5`) #)% J) 5`

OUTPUT 7 SPECIFICATIONS					
Parameter	Details	Min	Typ	Max	Units
Output voltage range	Top/Bottom channel	1.8/5	3.3/12	5/15	V
Rated current	Each channel			5	A
Average output power	Top/Bottom channel		60/16.5	75/25	Watts
Initial voltage accuracy	Factory set units	-1		1	%
Manual Voltage Adjust	11 turn potentiometer		0.3/0.9		V/turn
Load Regulation	Measured at sense terminals	-50		50	mV
Line Regulation	Measured at sense terminals	-0.1		0.1	%Vset
Cross Regulation	Measured at sense terminals	-0.2		0.2	%Vset
Minimum Load				0	Watts
Temperature drift	-20°C to +50°C	-0.02		0.02	%/°C
Ripple and Noise	20MHz BW, pk-pk			2	%Vset
Transient response (Vset = 5V/3.3V)	25% to 75% load transient at 1A per uS			1/0.5	V
	Recovery to within 10% of Vset			100/100	uS
Turn on rise time	Monotonic 10% to 90%	1		3.5	mS
Turn on overshoot				0.1	%Vset
Turn on delay	AC to PG		600	750	mS
	En to PG		15	20	mS
Holdup voltage	Top/Bottom channel			12/5	V
Isolation to ground	Each terminal			250	V
Over current protection	% of rated current	105		130	%rated
Reverse current protection	None				
Short circuit protection (Hiccup mode)	Period		30		mS
	Duty cycle		1		%
Over voltage protection	Latching Top/Bottom channel		20/8		V
Over Temperature protection	Internally monitored. Latching	115		125	°C
Power Good threshold	High and low window	68		120	%Vset
Reliability	25°C 100% load Telcordia			1	FPMH
Warranty				2	Years
Wire Size		24	22	20	AWG
Weight				60	Grams
Size	60mm x 35mm x 17mm				

Notes: All specifications are believed to be correct at time of publication and are subject to change without notice.

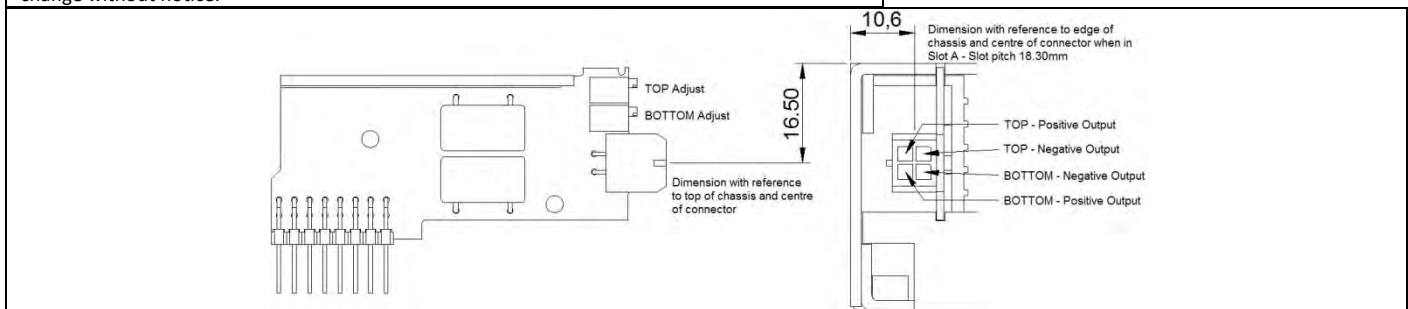
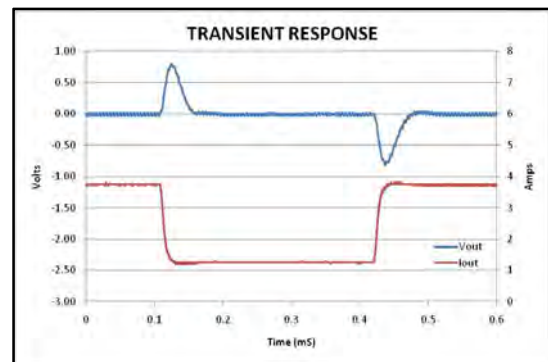
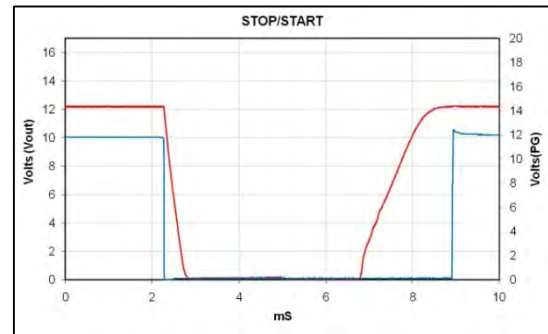
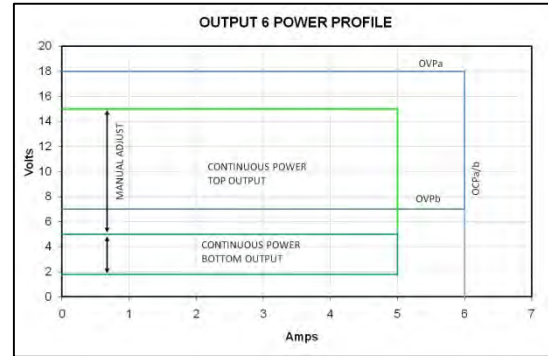

REF.	DETAILS	MANUFACTURER	HOUSING	TERMINAL
J1	OUTPUT POWER CONNECTOR: 4 Pin, with Friction lock, 20-24 AWG	MOLEX	430250400	430300001

Notes: 1. Terminal and Wire current rating must exceed maximum output current. 2. Direct equivalents may be used for any connector parts 3. All cables must be rated 105°C min, equivalent to UL1015